

## 序言

感谢您购买本公司的左右驱动封箱机

本手册就其基本结构、使用方法及操作注意事项加以说明，以利于安全、正确地使用机器，并提高机器的使用寿命，请在使用机器前仔细阅读此手册，请确保把手册交到最终用户手中，如果因技术更新导致本手册内容有所变动，恕不另行通知。

FX 系列封箱机是以 OPP 带为主要材料，对名类纸箱进行封底的机器。本机结构简单，操作方便，易于维修，广泛使用于各行各业，达到美观、高效的理想效果。

### 安全事项：

- .1 操作本机台前，操作员必须仔细阅读使用操作说明；
- .2 操作人员在操作本机时，不得将身体部位置于机器运转位置；
- .3 维修人员在维修保养前亦必须在进行仔细阅读本使用操作说明；
- .4 装卸胶带及正常保养或维修时，请务必关闭电源、气源，以策安全；
- .5 非经受训练过之人员，请勿随意靠近或触碰本机器；

## 目录

1 本机特性.....	3
2 机械结构及调节说明.....	4
3 机器操作流程.....	4
4 贴带器的调整及操作说明... ..	5
5 电路图.....	10
6 爆炸图.....	10
6.1 机体部分爆炸图及零件表.....	10
6.2 驱动带部分爆炸图及零件表.....	13
6.3 帖带器爆炸图及零件表.....	16

## 1 本机特性

本机是全自动封箱机功能的系列之产品，单机操作，经济而又高效，是较为理想的封箱设备，主要参数如下：

封箱宽度：150mm~500mm

封箱高度：150mm~500mm

封箱长度：150mm~+∞mm

台面高度：580mm~780mm

外形尺寸：L1200 mm ×W900 mm ×H1350 mm

封箱速度：0-20m/min

适用电源：220v/380v 50/60HZ

适用胶带：W（48、60、72）mm×L1000y

机械重量：120kg

## 2.机器结构及调整说明（见图一）：

图一

## 3. 机器操作流程

- 3.1 将已经装箱好的纸箱先人工折盖后送入封箱机，根据折好盖后纸箱的宽度  $W$  和高度  $H$ ，将机器的下驱动带宽度通过宽度调节手柄调节到与纸箱宽度相同的宽度  $W$ ，再将机器的上驱动带高度通过高度调节手柄调节到与纸箱高度相同的高度  $H$ 。如图二所示：

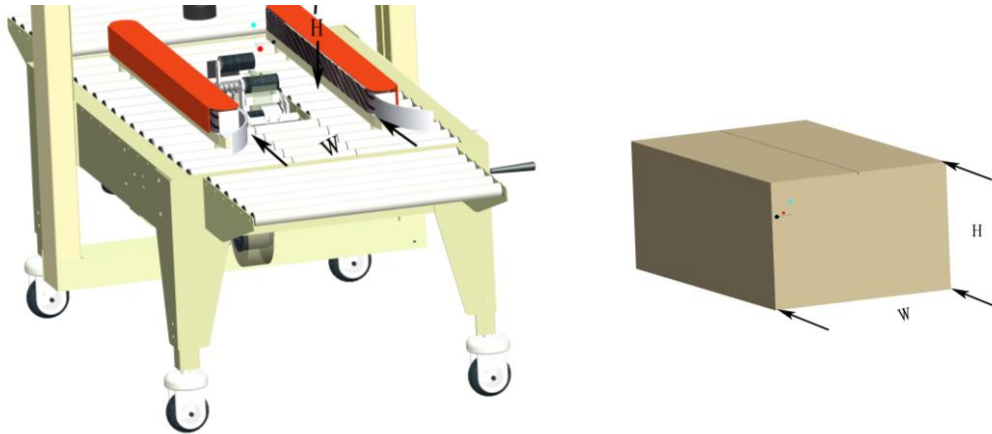

图二

3.2 打开机器电源开关，逐个将折好盖的纸箱送入封箱机中，在驱动带的带动下，完成纸箱上下贴封胶带。如图三示：

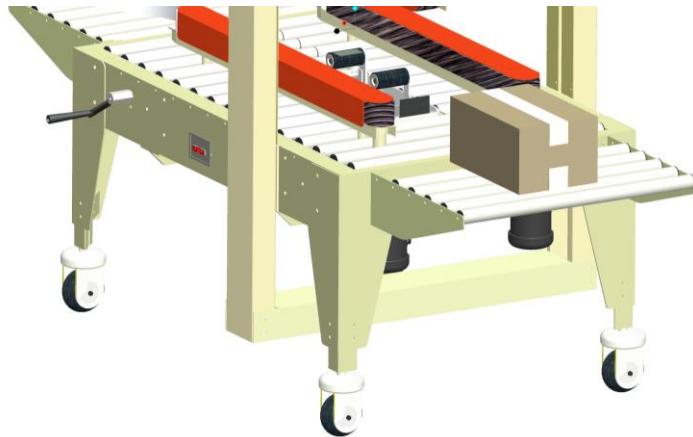

图三

4 贴带器的操作及调节 如图四示：

4.1 首先，将新 OPP 胶带卷放入芯轴上，如图所示.第二，拉出胶带，绕过滚筒 C 再沿线绕过滚筒 B，第三，绕过滚筒 D,最后将胶带穿过胶带座 E 从滚筒 F 穿出，如下图所示。在整个过程中一定要注意，胶带的粘性面一定要朝外。

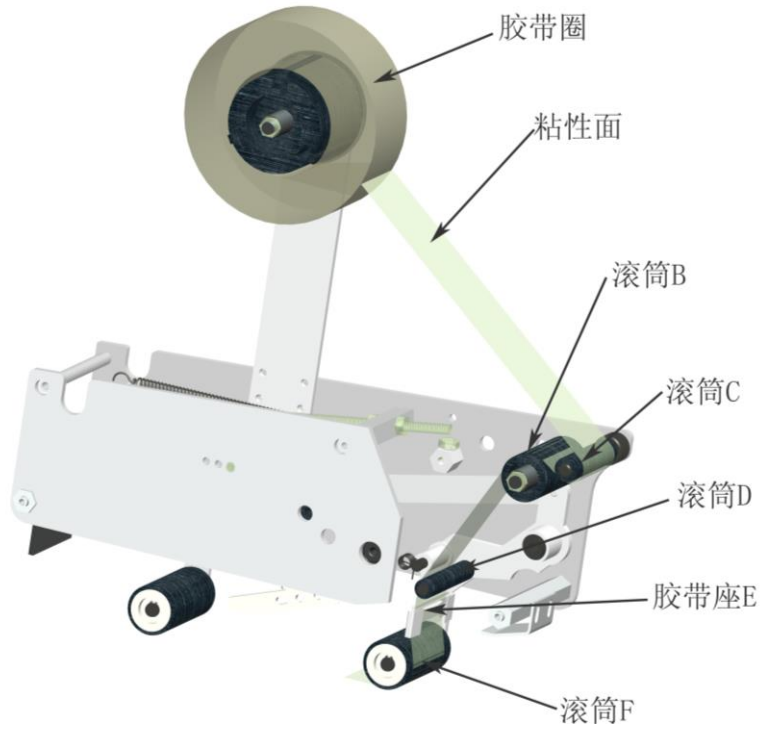

图四

4.2 胶带穿线图 如图五所示：



图五

4.3 胶带位置调整 如图六所示：

如果胶带不在箱子的中心线上，请参照下图进行调整：松开螺母

B，然后用螺丝刀调整心轴，从而可以调整胶带位置

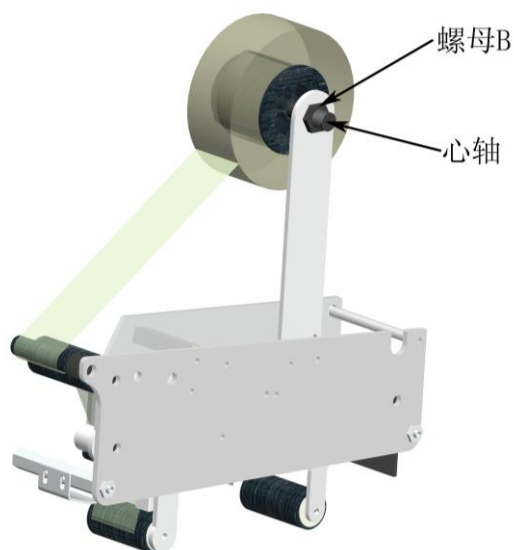

图六

4.4 胶带张力调整 如图七所示：

旋转旋钮，可以使胶带卷转速适中，并调松开螺母 M8,调整螺钉 M8×50 的前后位置，改变摆杆长拉簧的弹力，从而控制胶带张力的  
大小.顺时针旋转旋钮，胶带张力变大，反之变小;螺钉 M8×50 向前  
调整，胶带张力变大，反之变小。

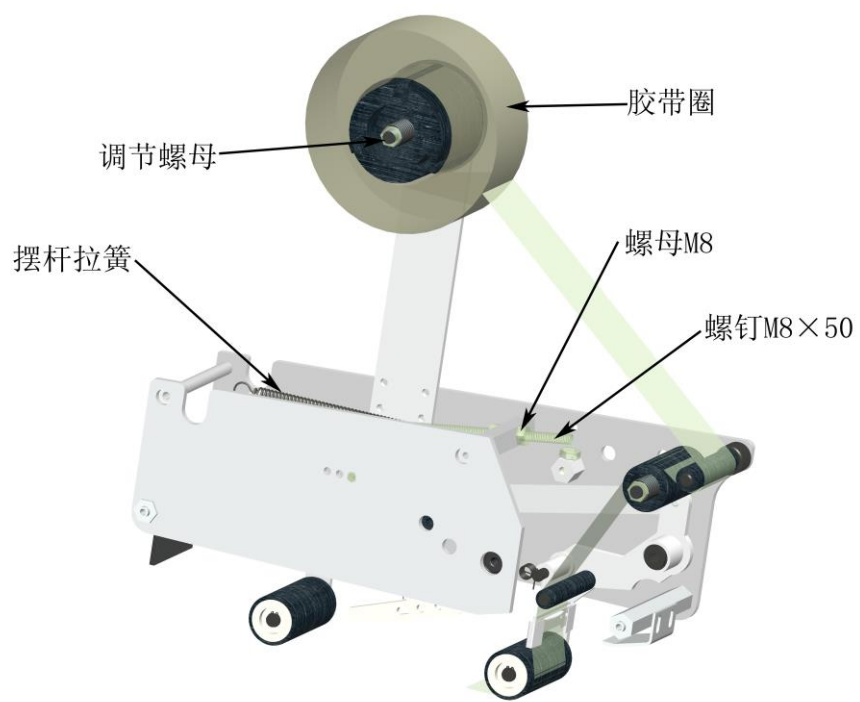

图七



## 封箱贴带异常排除说明

异常状况	原因	排除方法
胶带切不断	刀片已不锋利或胶带膜卡住刀尖	更换刀片；擦干净刀片及上油
胶带已切断但拖一节	刀座被卡住，动作不灵活或弹簧不够紧	检查贴带器各部位螺丝，或调节拉簧弹力
胶带有切断但未贴合箱面	主拉簧太松，后轮反弹速度无法与皮带速度吻合	适度锁紧主拉簧螺丝
纸箱走至中间被卡住不动	主拉簧太紧，前轮被陷在中间	适度放松胶带轮主拉簧
胶带容易落	单向滚轮失去效能	更换新单向滚轮
封箱后箱体偏歪及箱盖错角		封箱前，箱盖折平后两侧箱盖应与箱体对齐平行才可推入封箱机进行封箱
封箱后纸箱后段上的胶带有皱纹或贴附下来的胶带没有平整		调节贴带器上的螺母 M8 增大的拉力，如图八所示

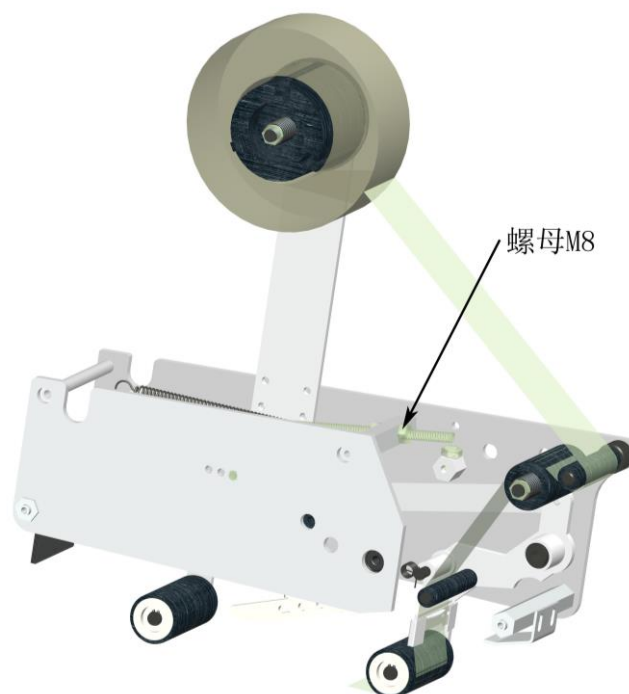

图八

## 5 电路图 如图九所示:

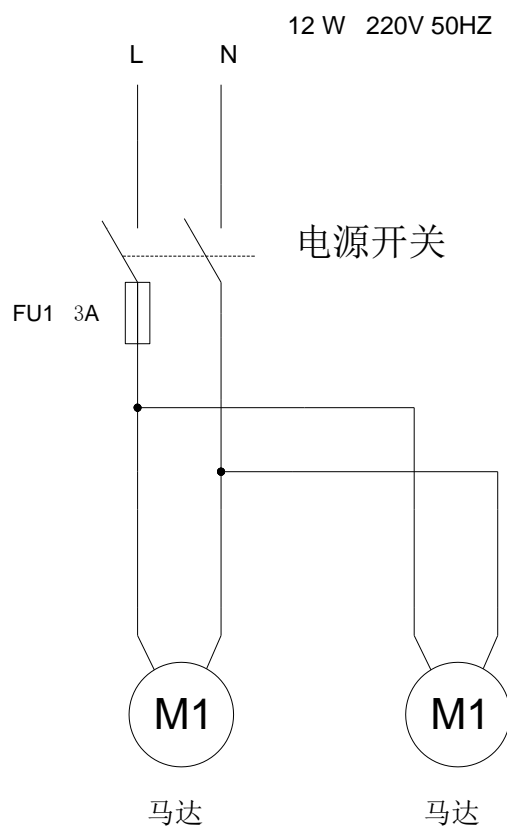

图九

## 6 爆炸图



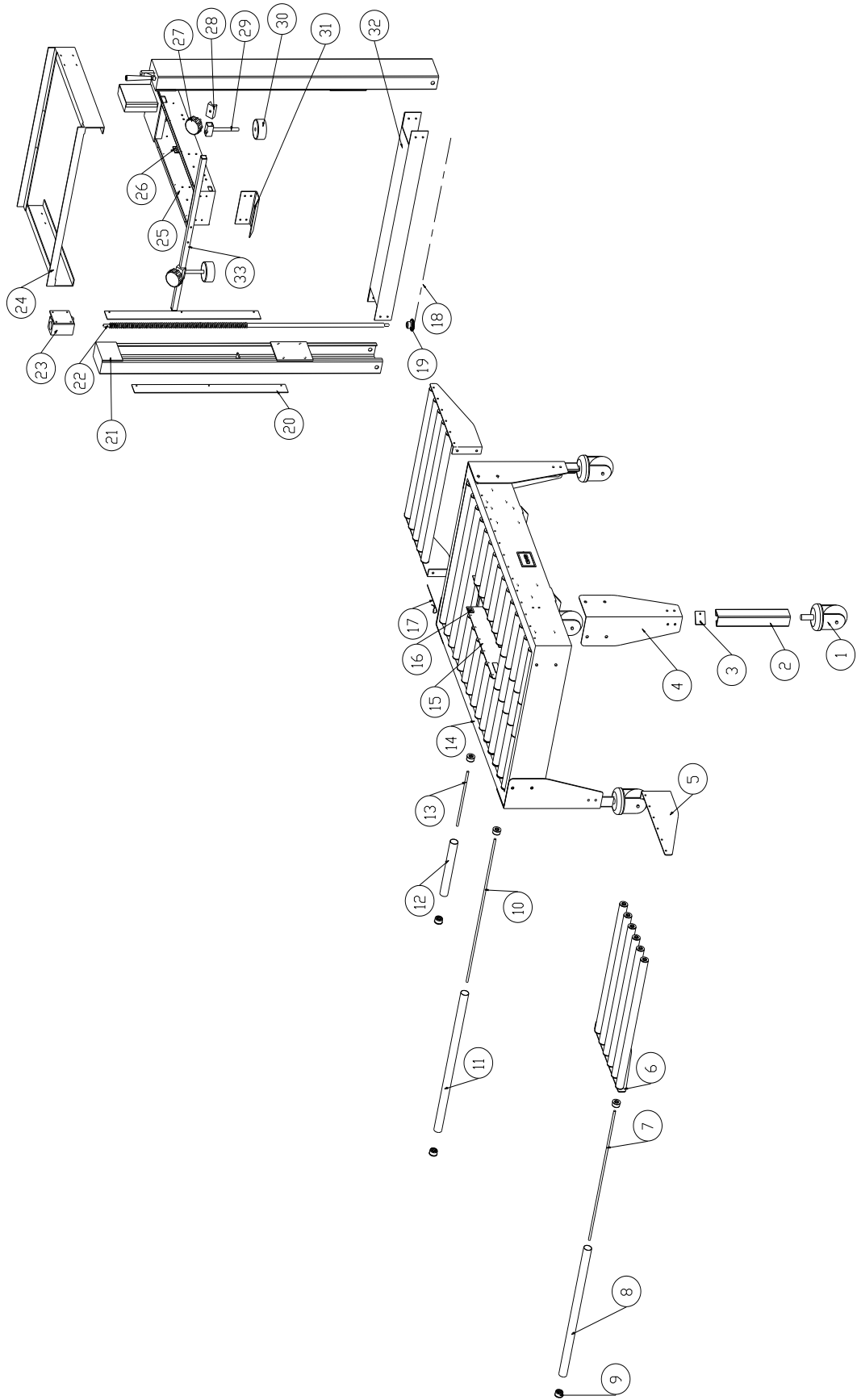















6.1 机体部分 如图十、表一所示:



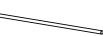



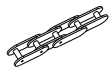

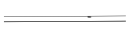

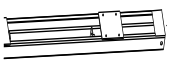

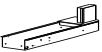

图十

零件表

表一

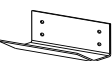
序号 ON	图形 DRAW	型号 PARTNO	名称 DESCRIPTION	数量	备注 MEMO
1		M16	脚轮	4	带止动
			Castors		
2		XL50P-03-01	调节机脚	4	
			adjust undercarriage		
3		XL50P-03-02	衫板	4	
			Solid Spruce		
4		XL50P-03-03	机脚	4	
			undercarriage		
5		XL50P-03-04	支架	2	
			bracket		
6		XL50P-03-05	支架	2	
			bracket		
7		XL50P-03-06	轴	12	
			axle		
8		XL50P-03-07	轴筒	12	
			beam barrel		
9		XL50P-03-08	轴套	62	
			bushing		
10		XL50P-03-09	轴	7	
			axle		
11		XL50P-03-10	轴筒	7	
			beam barrel		
12		XL50P-03-11	轴筒	12	
			beam barrel		
13		XL50P-03-12	轴	12	
			axle		
14		XL50P-03-13	机架	1	
			frame		
15		XL50P-03-15	卡板	2	
			catch plate		
16		XL50P-03-16	锁丝	7	
			pin		
17		08B	链条	1	
			cylinder		
18		XL50P-03-17	链轮	2	
			chain wheel		
19		XL50P-03-18	盖板	4	
			cover plate		

20		XL50P-03-19	立柱	2	
			upright column		
21		XL50P-03-20	轴	2	
			axle		
22		XL50P-03-21	轴套	2	
			bushing		
23		XL50P-03-222	托架	1	
			bracket		
24		XL50P-03-232	托架	4	
			bracket		
25		XL50P-03-242	卡板	2	
			catch plate		
26		XL50P-03-252	托架	1	
			bracket		
27			手柄	2	
			handle		
28		XL50P-03-262	压块	2	
			lock block		
39		XL50P-03-272	压轮杆	2	
			adjuster lever		
30		XL50P-03-282	压轮	2	
			claying roller		
31		XL50P-03-292	导板	1	
			guide plate		
32		XL50P-03-302	盖	1	
			cover		
33		XL50P-03-312	压轮杆	1	
			adjuster lever		

6.2 驱动带部分 如图十一、表二所示：

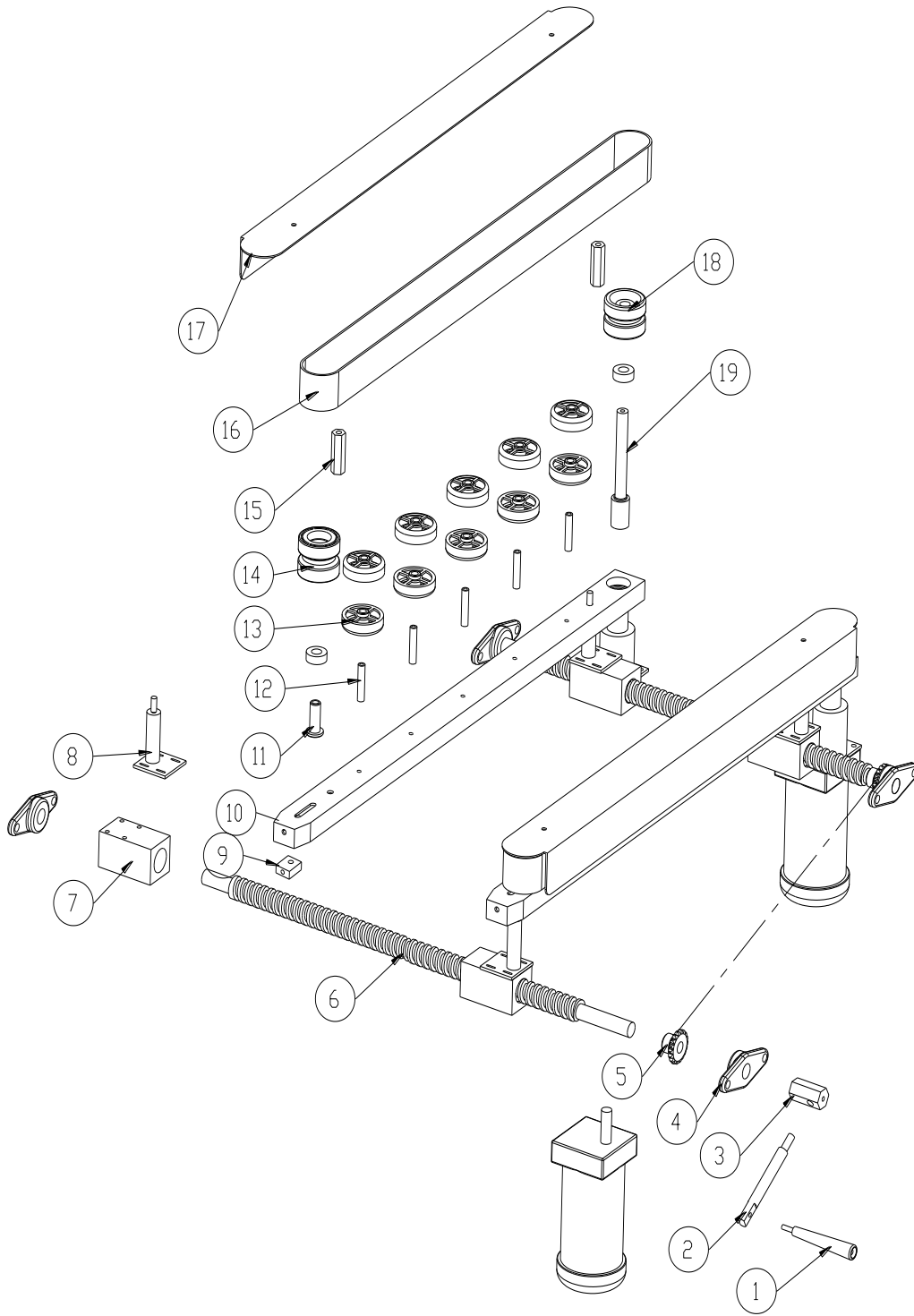

图十一  
零件表

表二

序号 DRAW	图号 PARTNO	名称 DESCRIPTION	数量 QTY	备注 MEMO
1		手柄	2	
		handle		
2		XL50P-02-01 手柄轴	2	
		handle setting shaft		
3		XL50P-02-02 手柄座	2	
		handle setting		
4		轴承座	4	
		unit bearing		
5		XL50P-02-03 链轮	2	
		chain wheel		
6		XL50P-02-04 丝杆	2	
		screw rod		
7		XL50P-02-05 滑座	4	
		Sliding base		
8		XL50P-02-06 支架	4	
		bracket		
9		XL50P-02-07 调节块	2	
		adjusting slider		
10		XL50P-02-08 支架	2	
		bracket		
11		XL50P-02-09 销轴	2	
		pin roll		
12		XL50P-02-10 销轴	10	
		pin roll		
13		XL50P-02-11 托轮	20	
		supporting roller		
14		XL50P-02-12 从动轮	2	
		driven wheel		
15		XL50P-02-13 支撑杆	4	
		support bar		
16		复合传送带	2	
		Belt conveyor		
17		XL50P-02-14 盖板	2	
		cover plate		
18		XL50P-02-15 主动轮	2	
		drive wheel		
19		XL50P-02-16 主动轴	2	
		driving axle		

6.3 贴带部分 如图十二、表三所示:



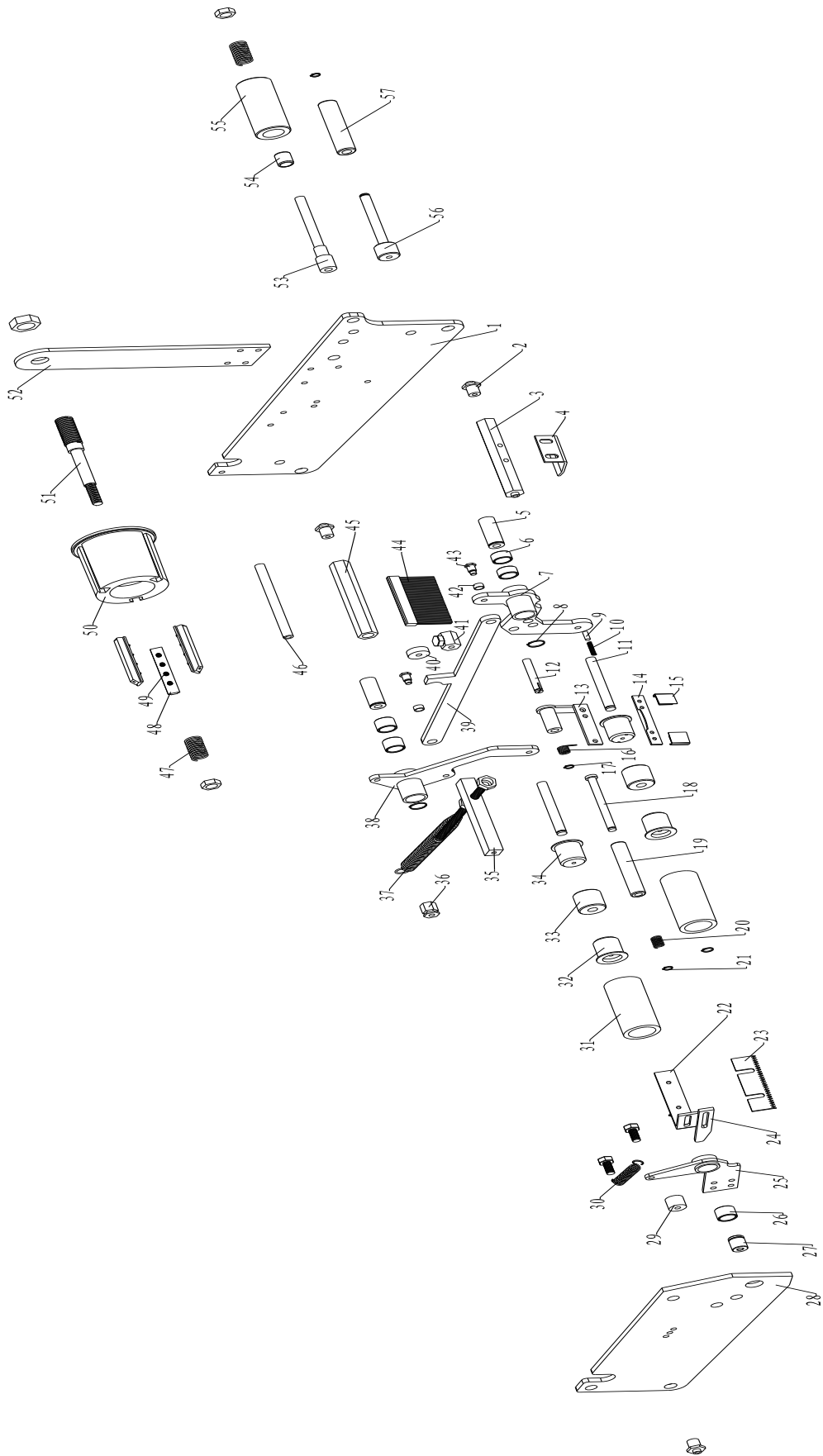









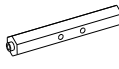
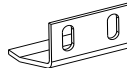





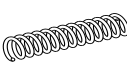

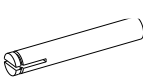
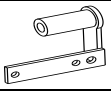
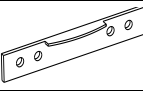



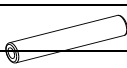

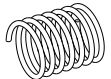

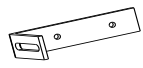
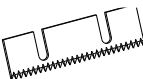
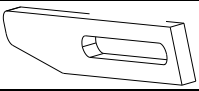

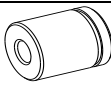



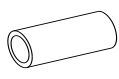

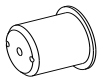
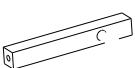
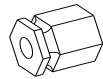

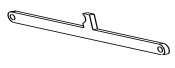





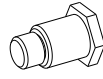

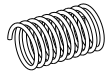

图十二

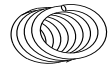
零件表

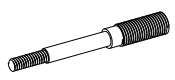
表三

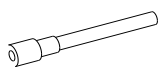
序号	图形 DRAW	型号 PARTNO	名称 DESCRIPTION	数量 QTY	备注 MEMO
1		GPE50-01-01	后墙板	1	
			board		
2		GPE50-01-07	定位螺栓	3	
			positioning bolt		
3		GPE50-01-06	定位杆	1	
			locating rod		
4		GPE50-01-08	导向板	1	
			director plate		
5		GPE50-01-22	轴	2	
			axle		
6		GPE50-01-21	衫套	4	
			axle set		
7		GPE50-01-20	摆臂	1	
			swing arm		
8		Φ16	轴用弹性挡圈	4	
			check ring		
9		GPE50-01-34	销轴	1	
			pin roll		
10		GPE50-01-33	压簧	1	
			Pressure spring		
11		GPE50-01-31	轴	2	
			axle		
12		GPE50-01-29	轴	1	
			axle		
13		GPE50-01-27	摆臂	1	
			swing arm		
14		GPE50-01-26	胶带顶片	1	
			top-plate		
15		GPE50-01-30	扣片	2	
			cleats		
16		GPE50-01-28	扭簧	1	
			torsion spring		
17		Φ8	轴用弹性挡圈	2	
			check ring		
18		GPE50-01-23	轴	1	
			axle		
19		GPE50-01-25	导向辊	1	

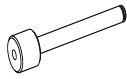
			guide roll		
20		GPE50-01-24	压簧	1	
			Pressure spring		
21		Φ10	轴用弹性挡圈	4	
			check ring		
22		GPE50-01-50	支架	1	
			bracket		
23		GPE50-01-51	切刀	1	
			slitter		
24		GPE50-01-49	触杆	1	
			feeler lever		
25		GPE50-01-48	刀架	1	
			knife rest		
26		GPE50-01-47	衫套	1	
			axle set		
27		GPE50-01-46	销轴	1	
			pin roll		
28		GPE50-01-02	前墙板	1	
			board		
29		GPE50-01-40	缓冲套	1	
			cushion collar		
30		GPE50-01-44	拉簧	1	
			tension spring		
31		GPE50-01-32	套	2	
			set		
32		GPE50-01-57	轴套	3	
			axle set		
33		GPE50-01-58	隔套	2	
			spacer bush		
34		GPE50-01-56	轴套	1	
			axle set		
35		GPE50-01-04	支撑杆	1	
			support bar		
36		GPE50-01-43	拉簧座	1	
			tension spring seat		
37		GPE50-01-44	拉簧	1	
			tension spring		
38		GPE50-01-42	摆臂	1	
			swing arm		
39		GPE50-01-37	连杆	1	
			connecting link		

40		GPE50-01-41	缓冲套	1	
			cushion collar		
41		GPE50-01-36	挡块	1	
			baffle plate		
42		GPE50-01-38	套	2	
			set		
43		GPE50-01-39	销轴	2	
			pin roll		
44		GPE50-01-35	毛刷	1	
			Brushers		
45		GPE50-01-05	定位杆	1	
			locating rod		
46		GPE50-01-03	支撑杆	1	
			support bar		
47		GPE50-01-10	压簧	2	
			Pressure spring		
48		GPE50-01-12	导条	3	
			conducting bar		
49		GPE50-01-13	压簧	12	
			Pressure spring		
50		GPE50-01-09	轮毂	1	
			Wheel Hub		
51		GPE50-01-11	轴	1	
			axle		
52		GPE50-01-14	支撑板	1	
			retaining plate		
53		GPE50-01-15	轴	1	
			axle		
54		GPE50-01-16	轴套	1	
			axle set		
55		GPE50-01-17	导向辊	1	
			guide roll		
56		GPE50-01-19	轴	1	
			axle		
57		GPE50-01-18	导向辊	1	
			guide roll		